

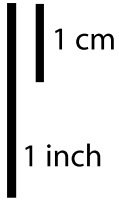

SPACE-X "Falcon-9 v1.2"

Print on Cardstock (110 lbs)

Fairing 1.0 Revision



JCSAT-14

1:100 Scale

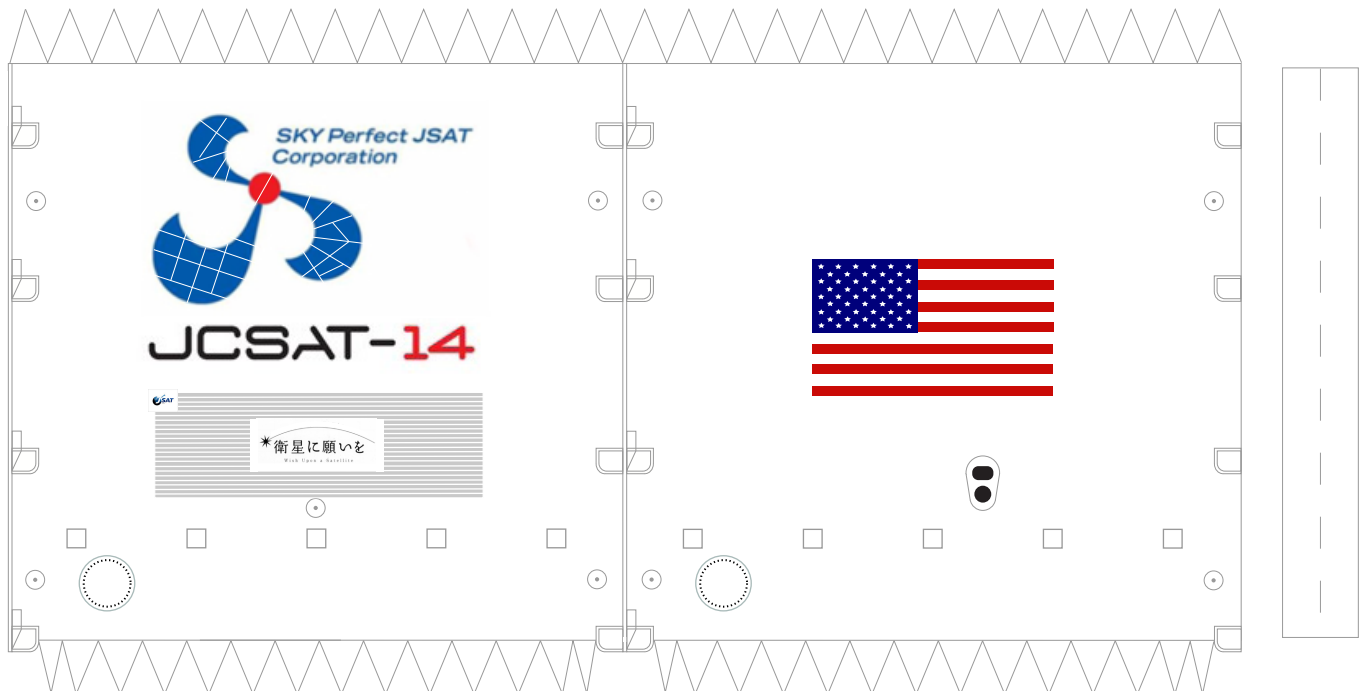
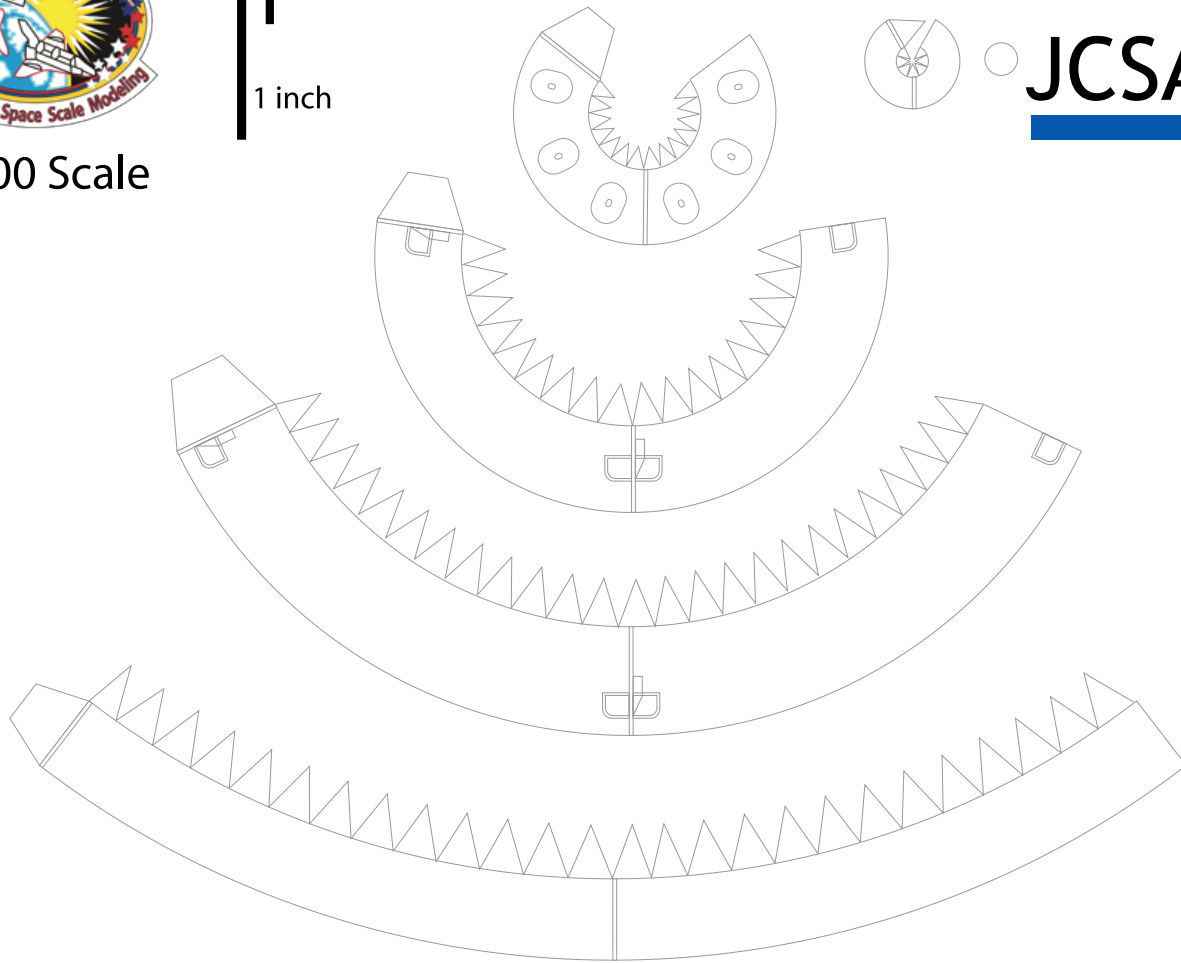



SPACE-X "Falcon-9 v1.2"

Print on Cardstock (110 lbs)

Rev. 2

1 cm

1 inch

Enlarged Second Stage / Interstage

1:100 Scale

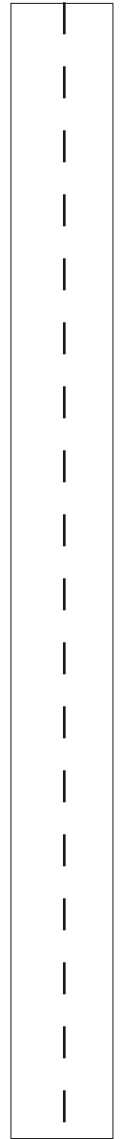
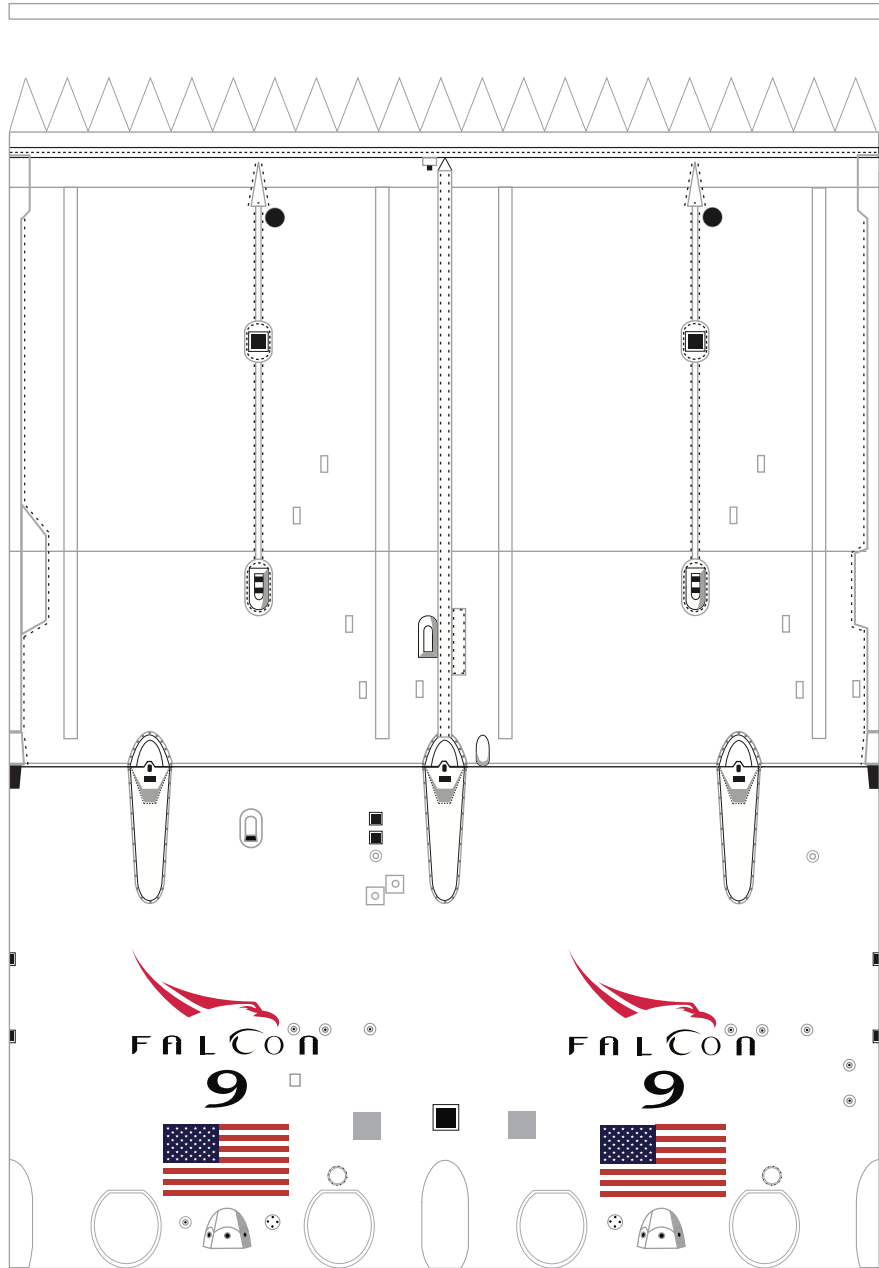
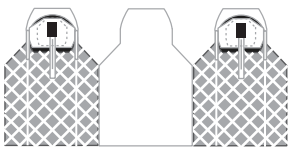
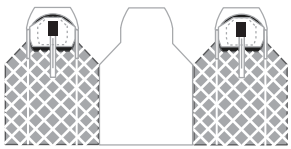
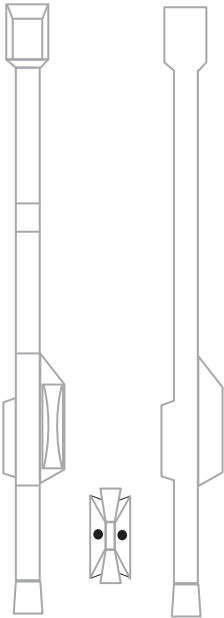

Modified Grid Fins

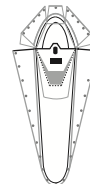
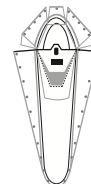
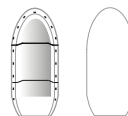
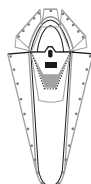
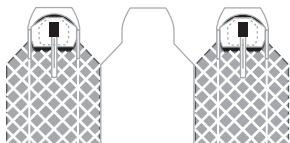



1:100 Scale



Falcon-9/ Interstage - First Stage

Connector



SPACE-X "Falcon 9 v1.2"

Print on Cardstock (110 lbs)

Block 2

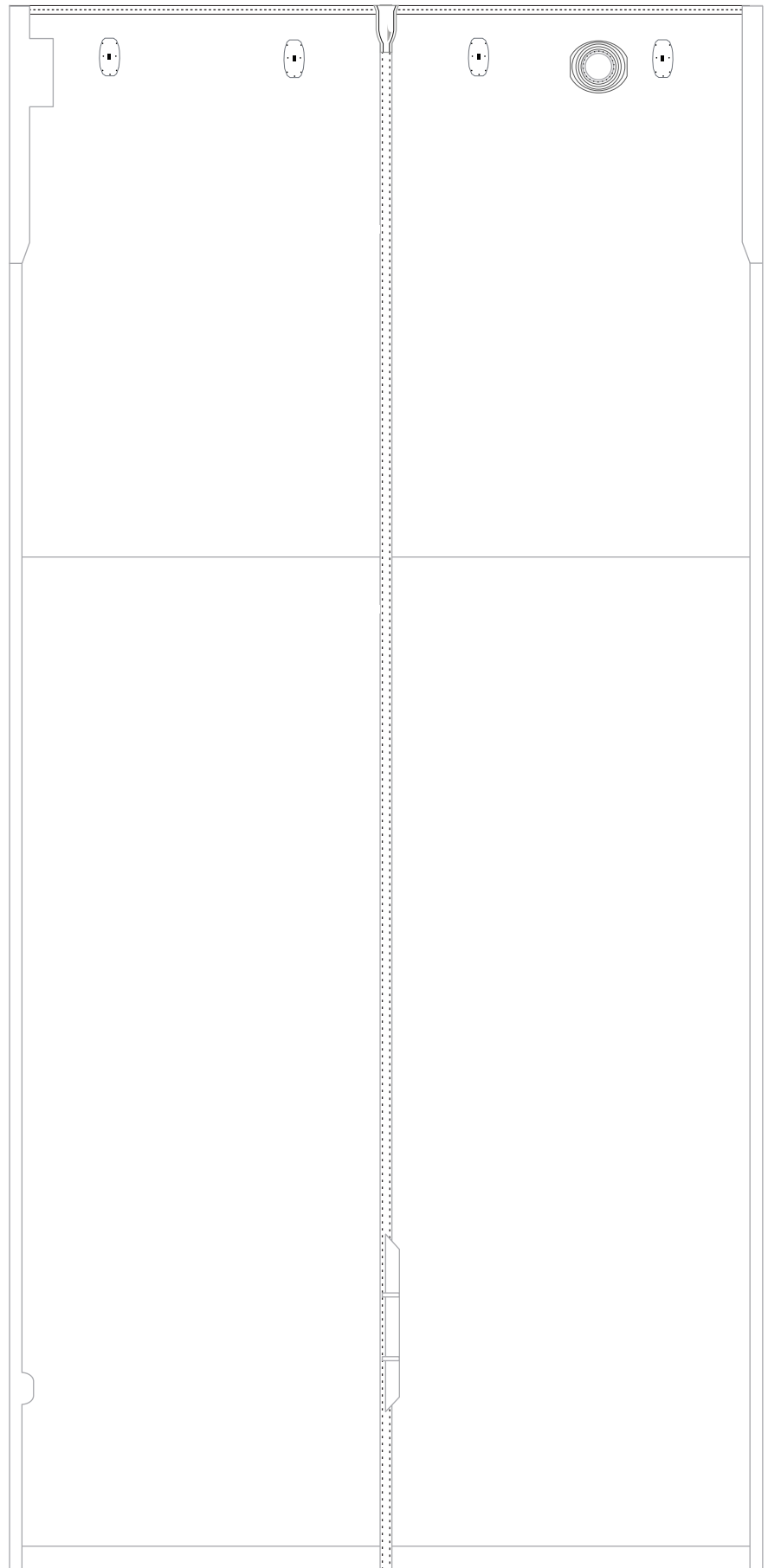



1:100 Scale



FALCON
9

SPACE-X "Falcon-9 v1.2"

Print on Cardstock (110 lbs)

Block 2

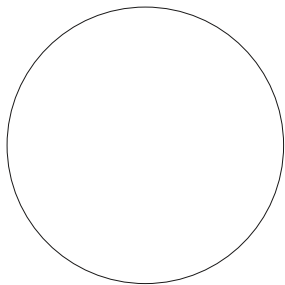
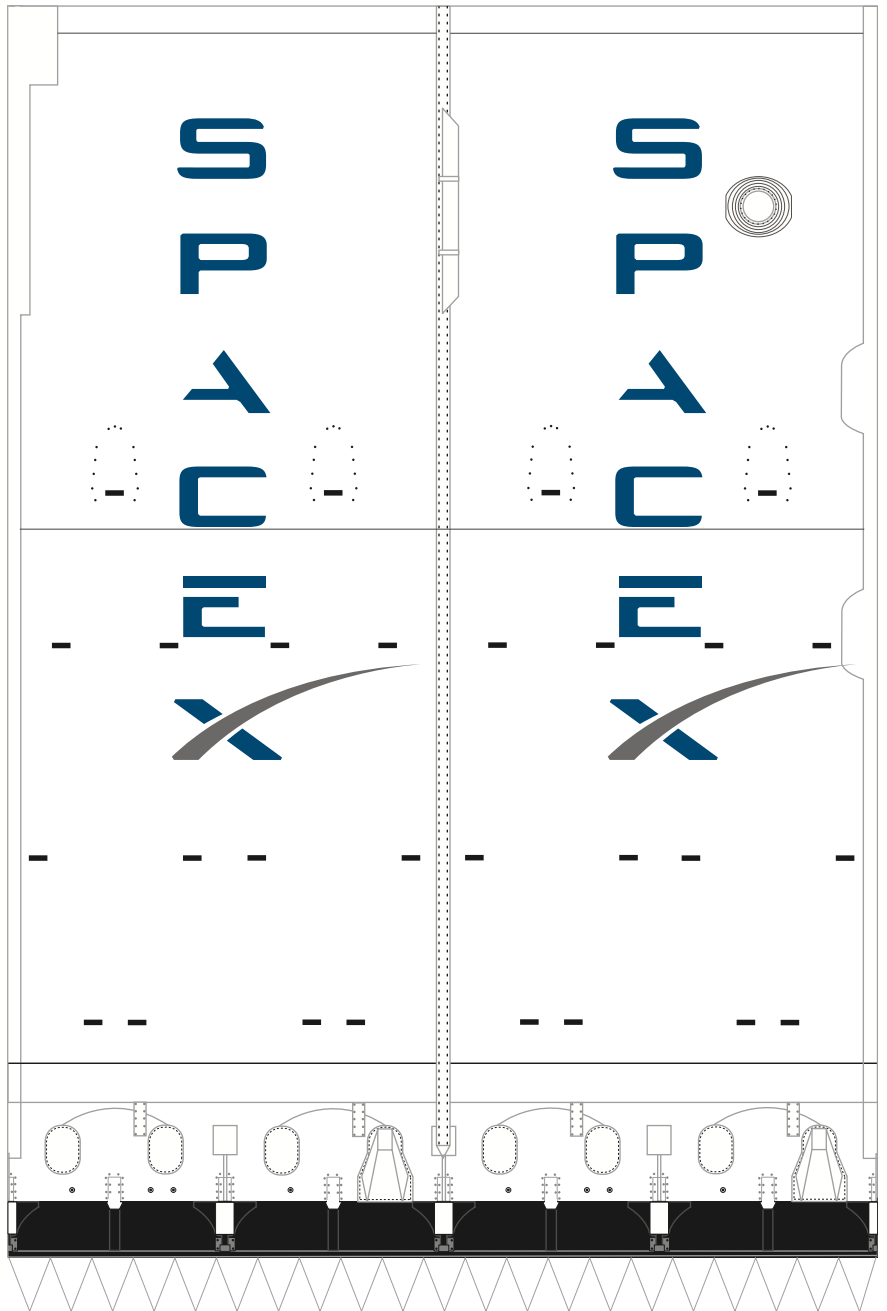
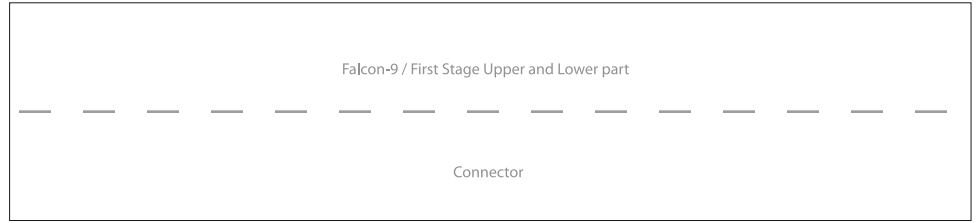
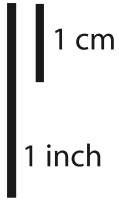



1:100 Scale



SPACE-X "Falcon 9 v1.2"

Print on Cardstock (110 lbs)

Rev.1

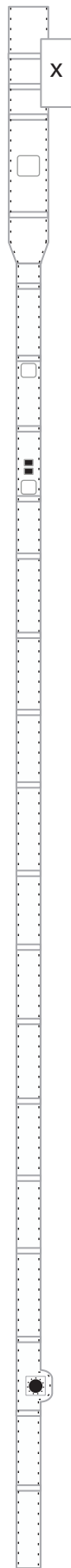
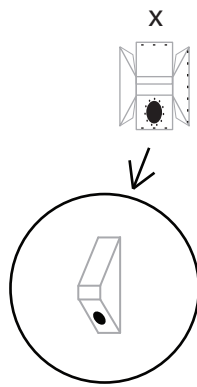

Thicker Raceway

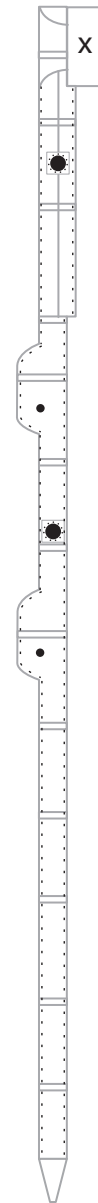

Fairing Connector

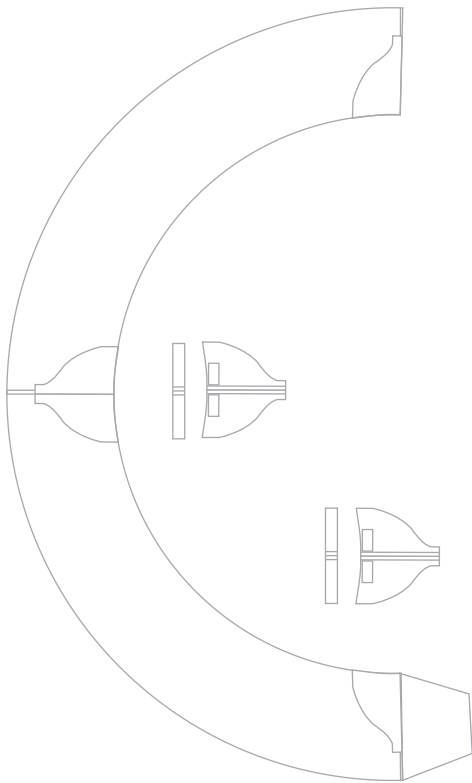



SPACE-X "Falcon-9 v1.2"

Print on Cardstock (110 lbs)

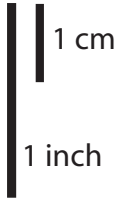

LEGS



1:100 Scale

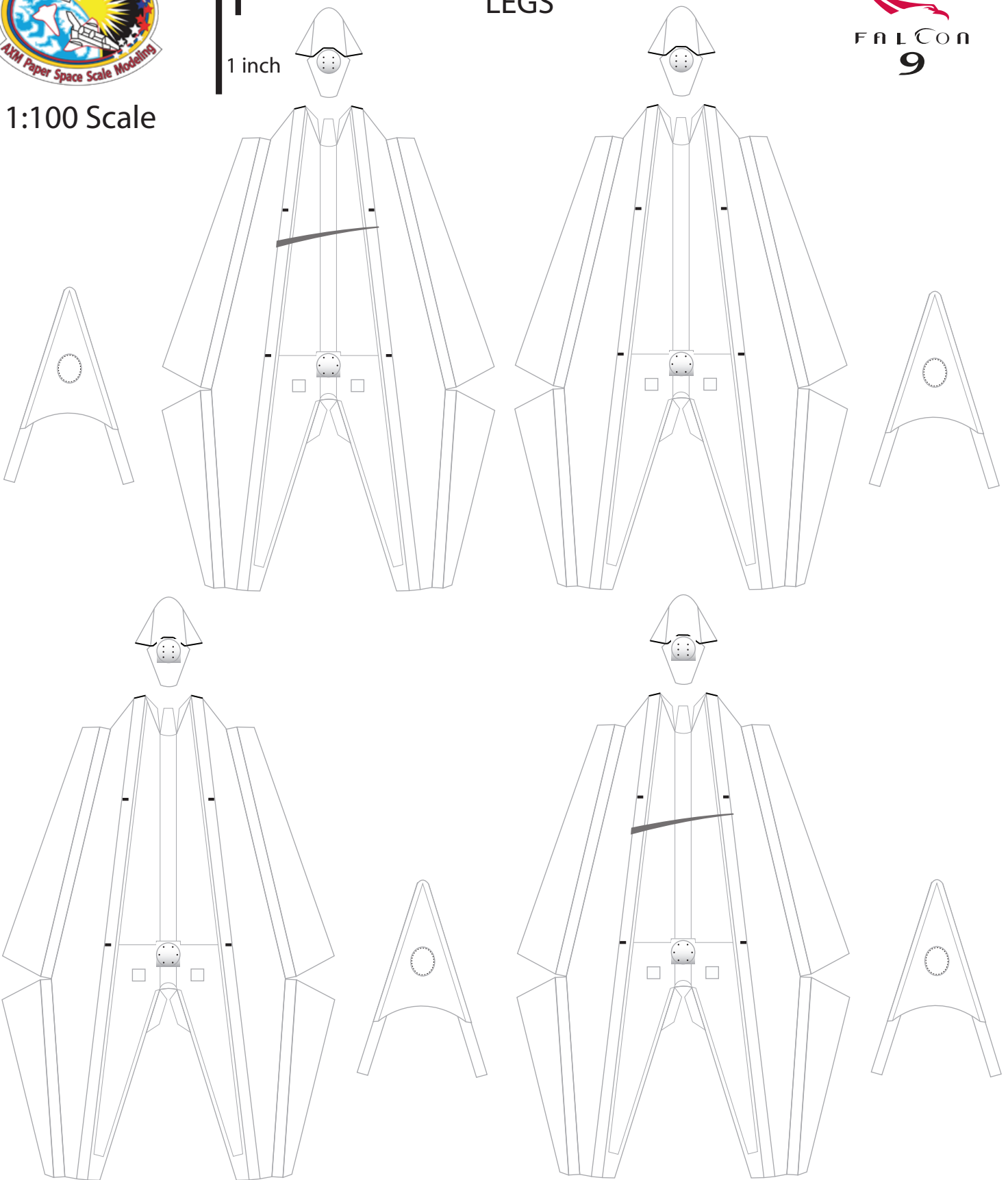



SPACE-X "Falcon-9 v1.2"

Print on Cardstock (110 lbs)

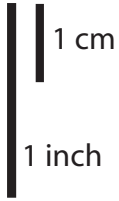

LEGS page 2



1:100 Scale

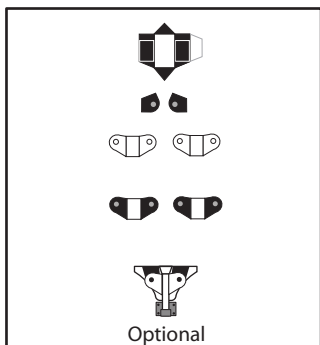
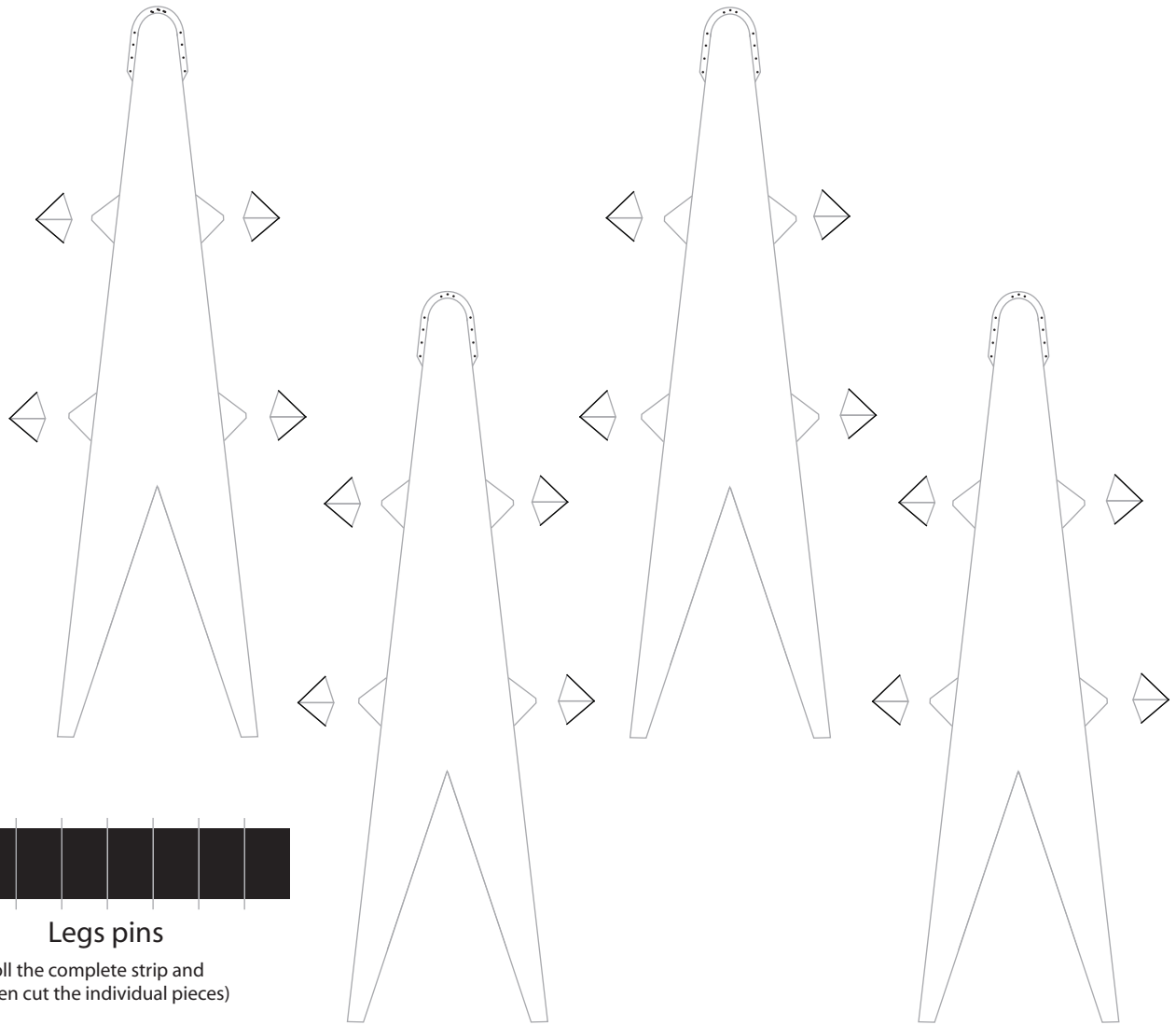

Optional

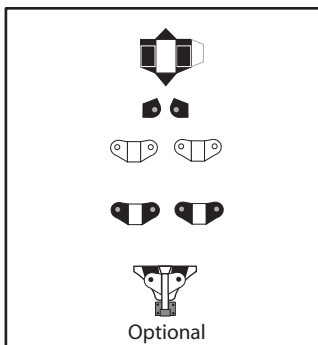

Optional

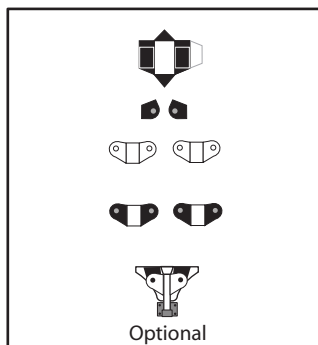

Optional

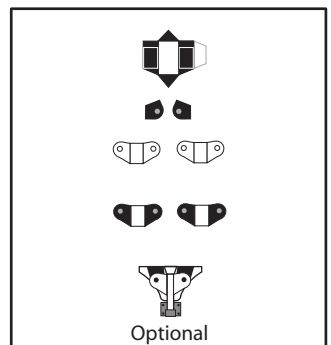

Optional



1:100 Scale



SPACE-X "Falcon-9 v1.2"

MERLIN Engines

Print on Cardstock (110 lbs)

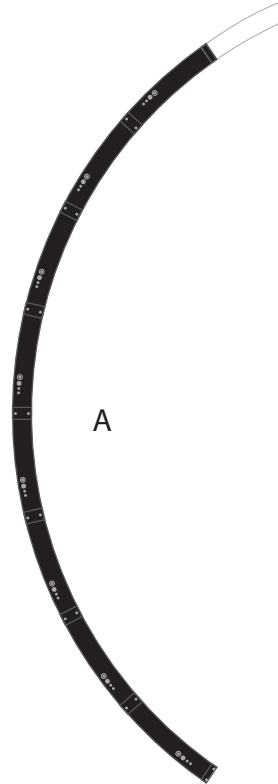
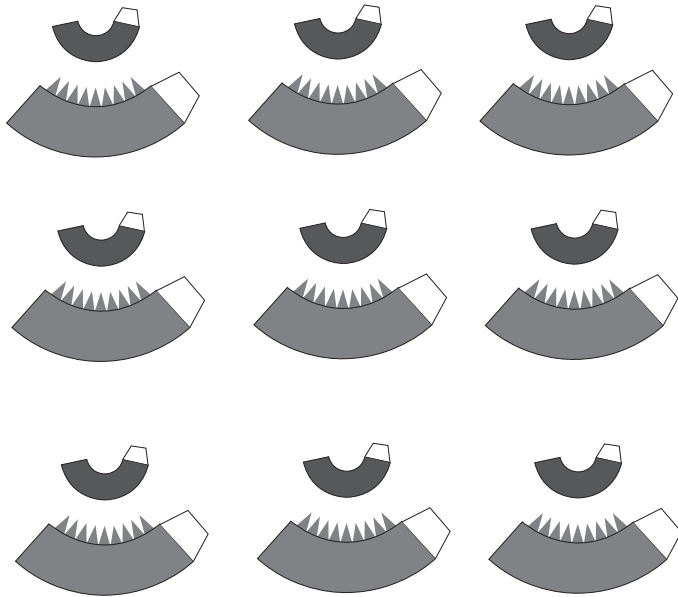

C

B

A

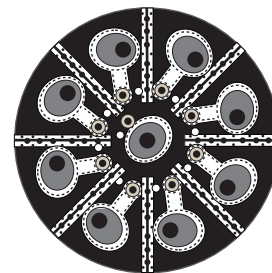
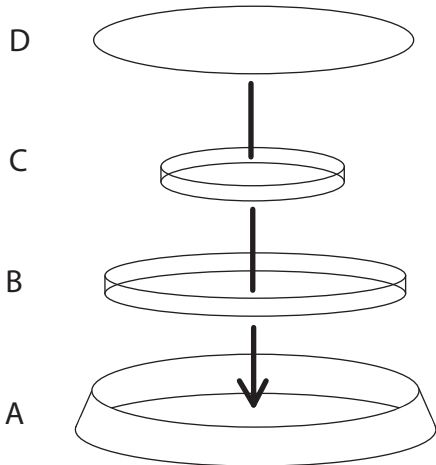

D

Engine Grid
OCTAWEB