



Print on Cardstock (110 lbs)

SCaN Testbed FRAM

Sheet 1

1:10 Scale

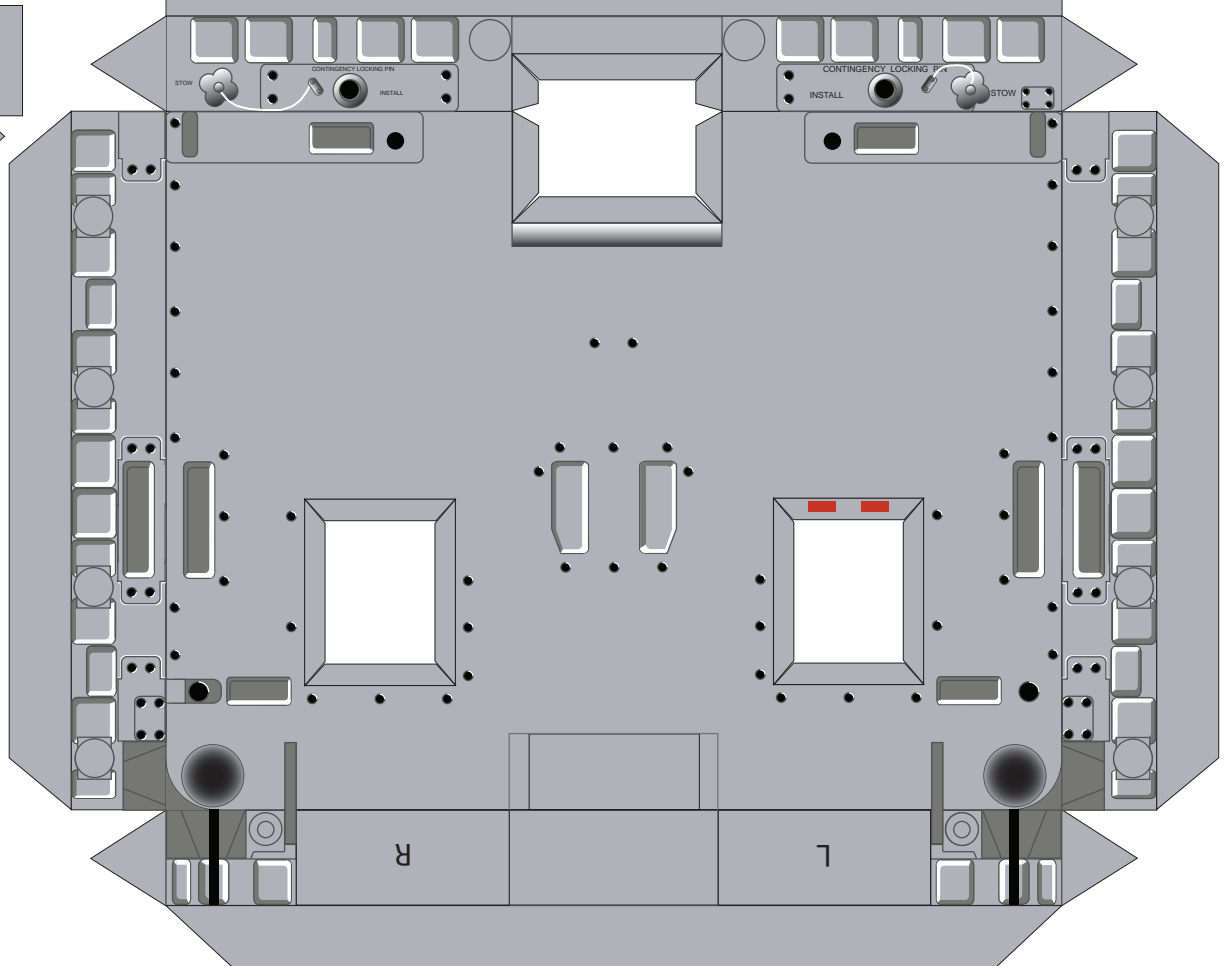
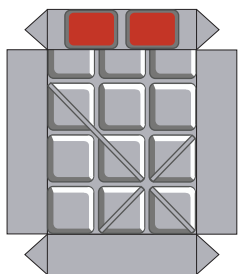
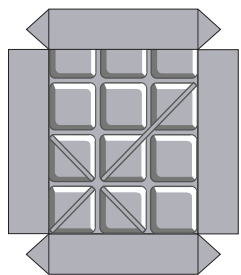
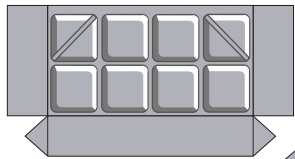
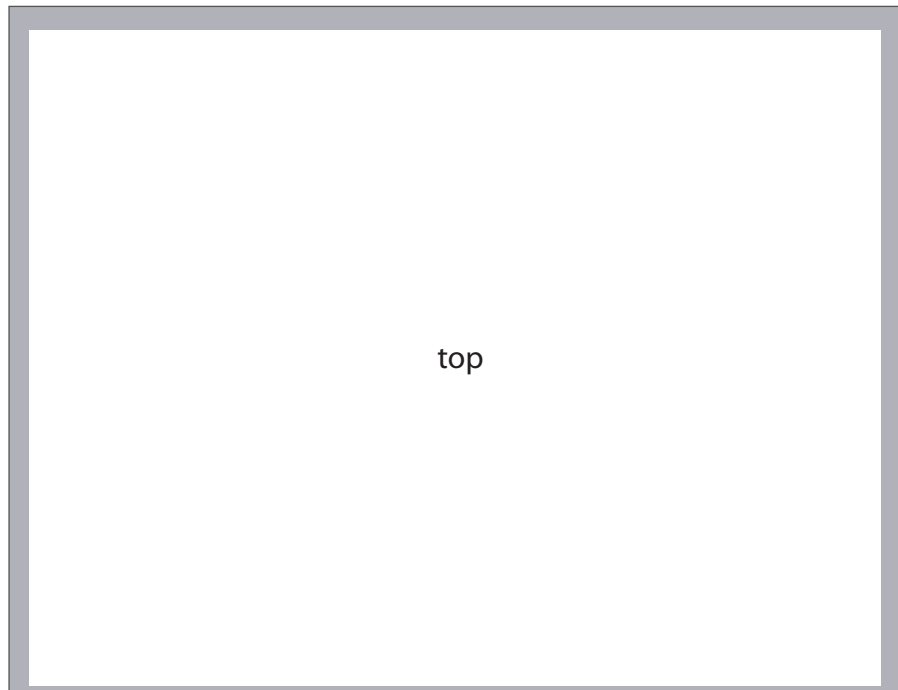
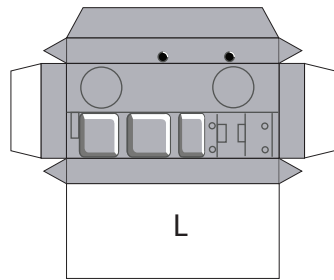
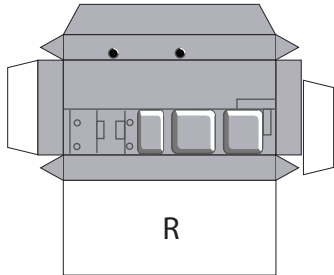

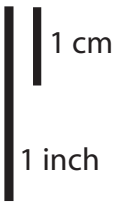

Print on Cardstock (110 lbs)

Sheet 2

SCaN Testbed FRAM

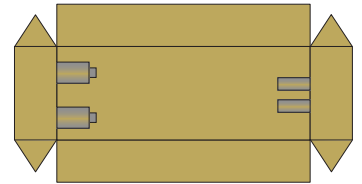

1:10 Scale

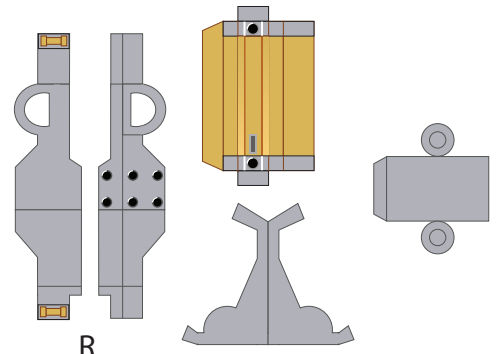
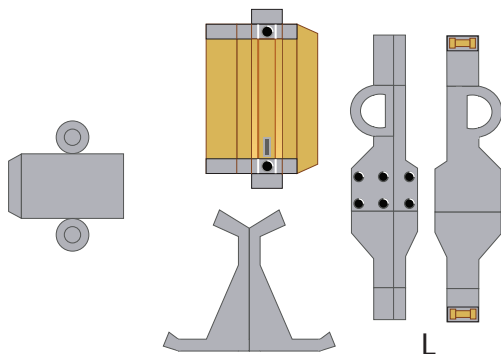
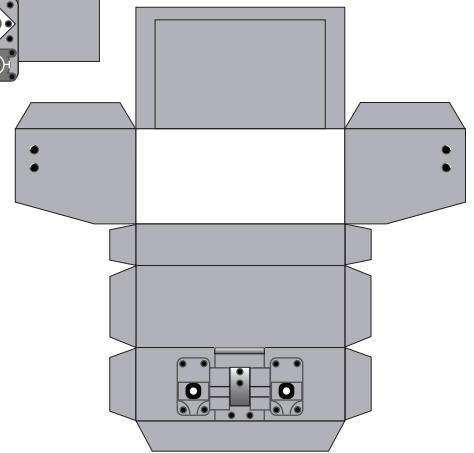
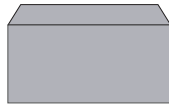
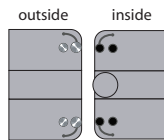
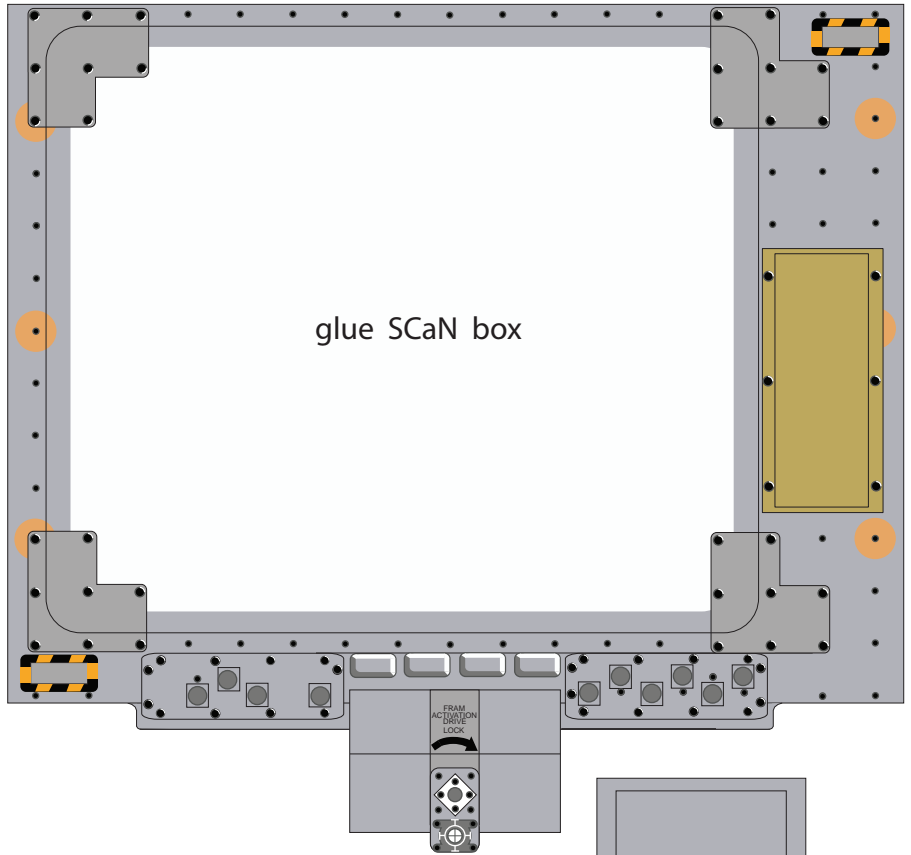
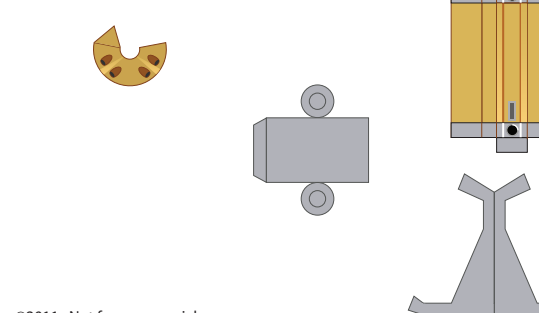
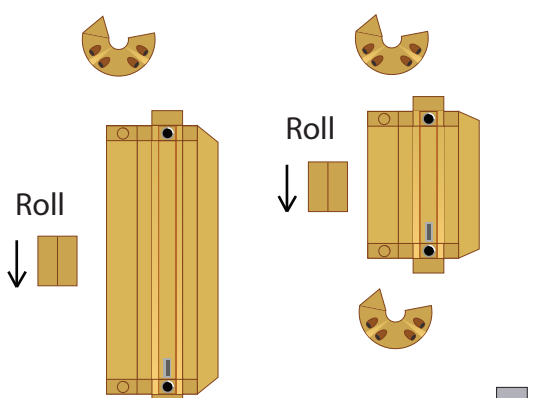
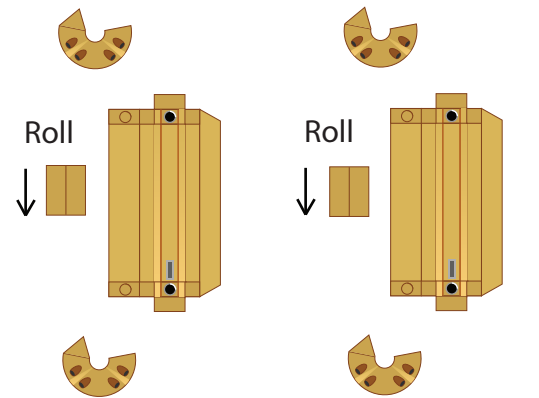
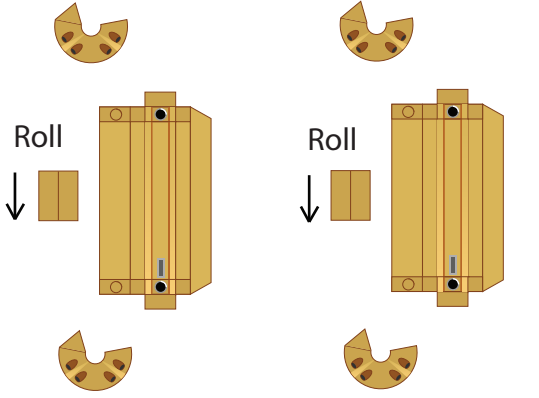

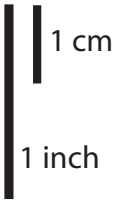

Print on Cardstock (110 lbs)

Sheet 3

SCaN Testbed

Main box

1:10 Scale

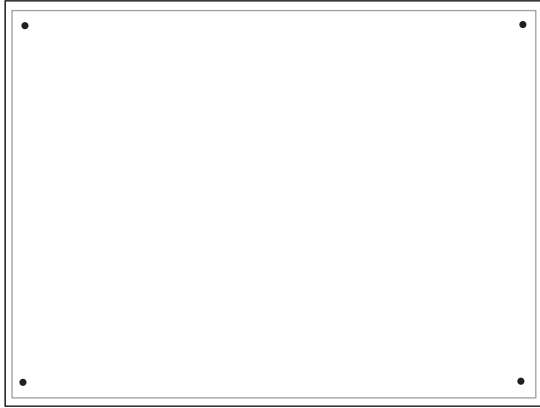

D

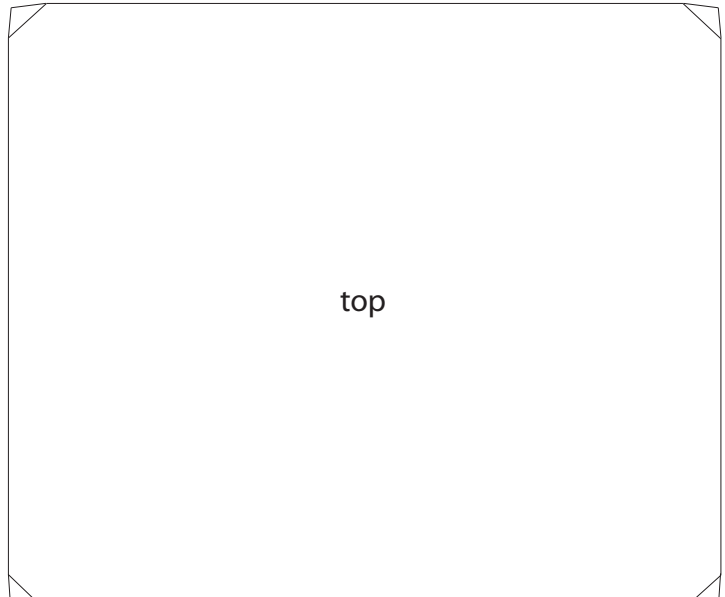

top

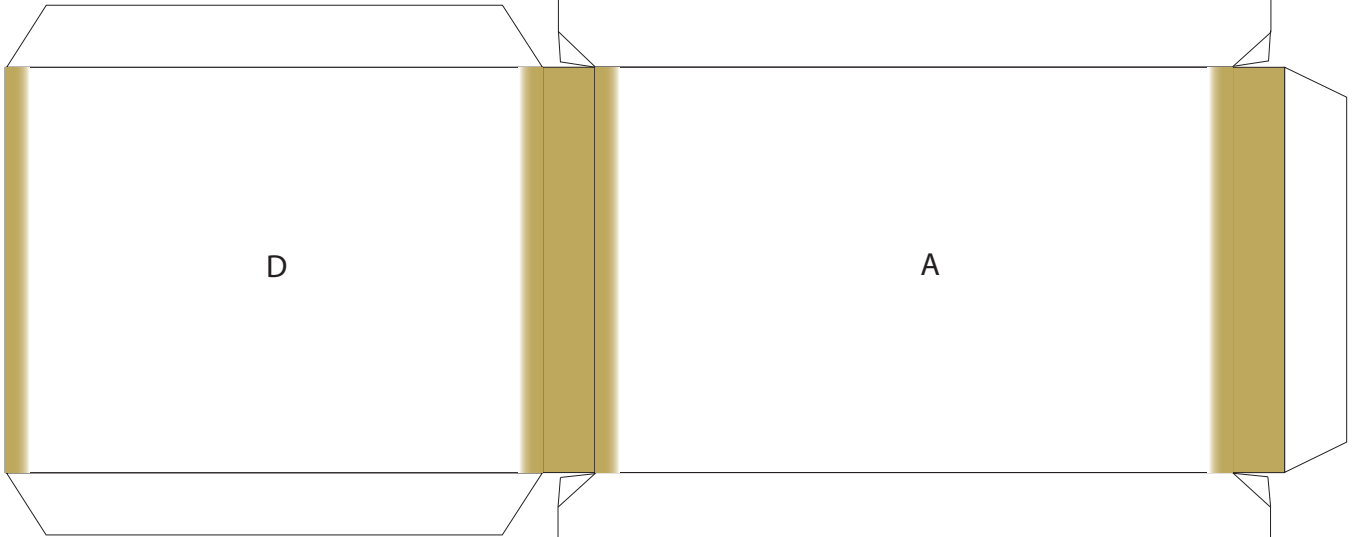

D

A

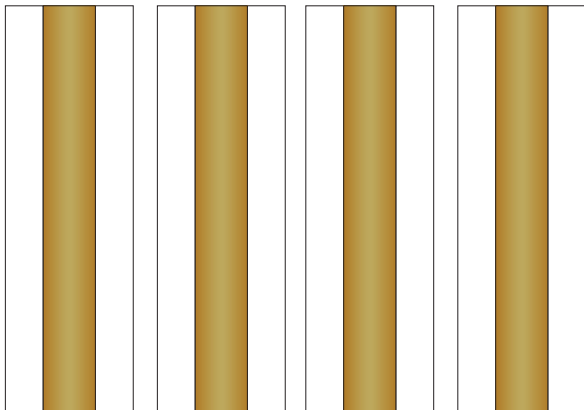

corners

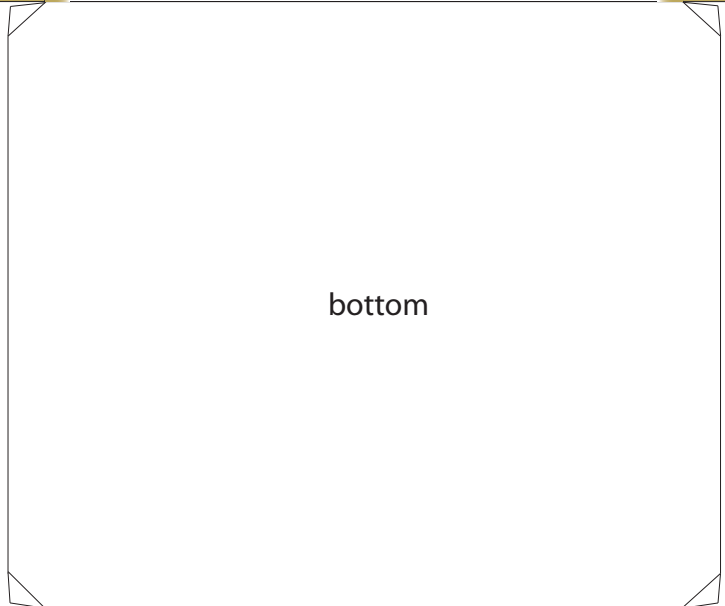

bottom

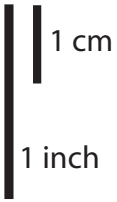

Print on Cardstock (110 lbs)

1:10 Scale

SCaN Testbed

Sheet 4

Main box

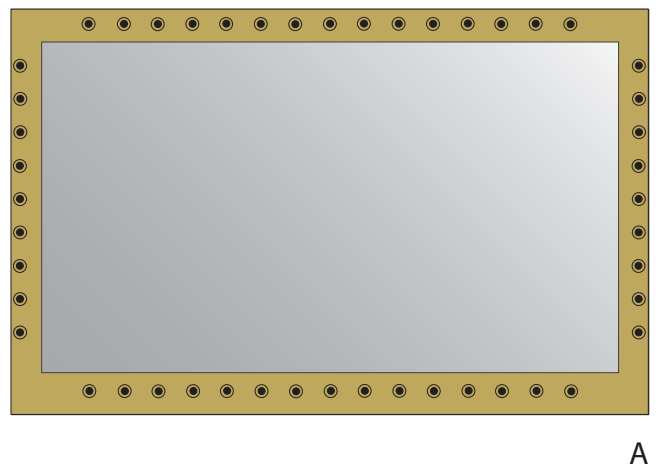
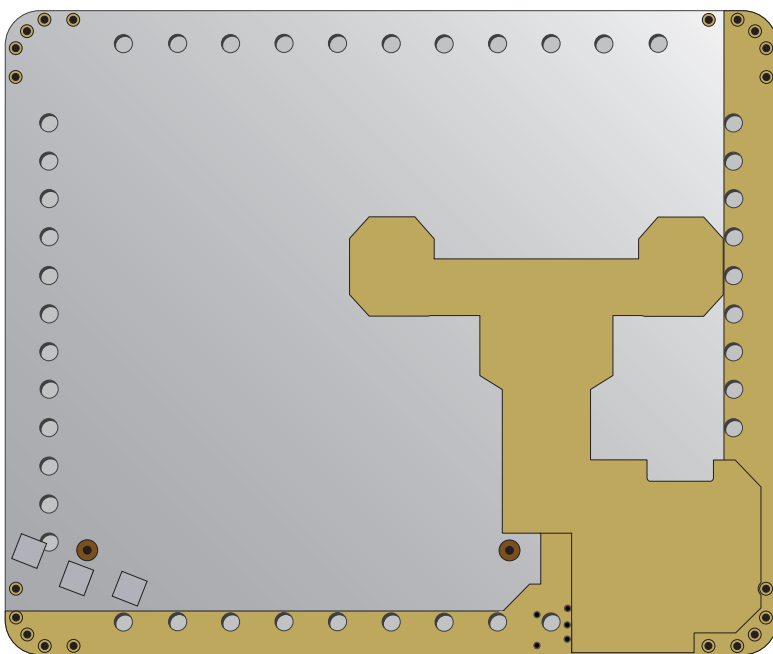
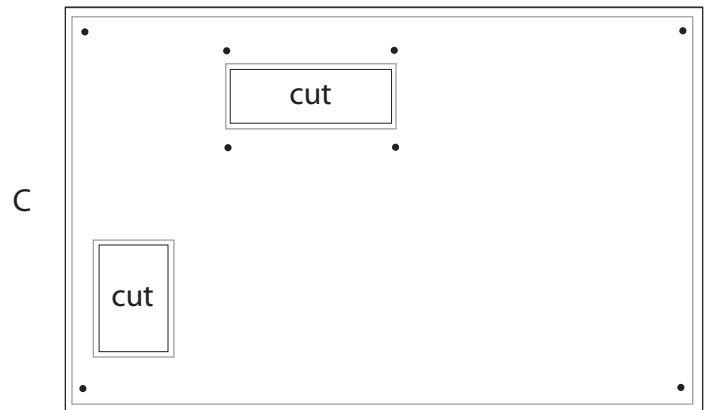
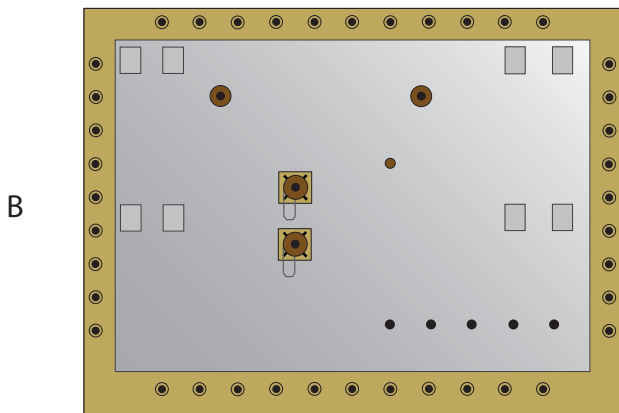
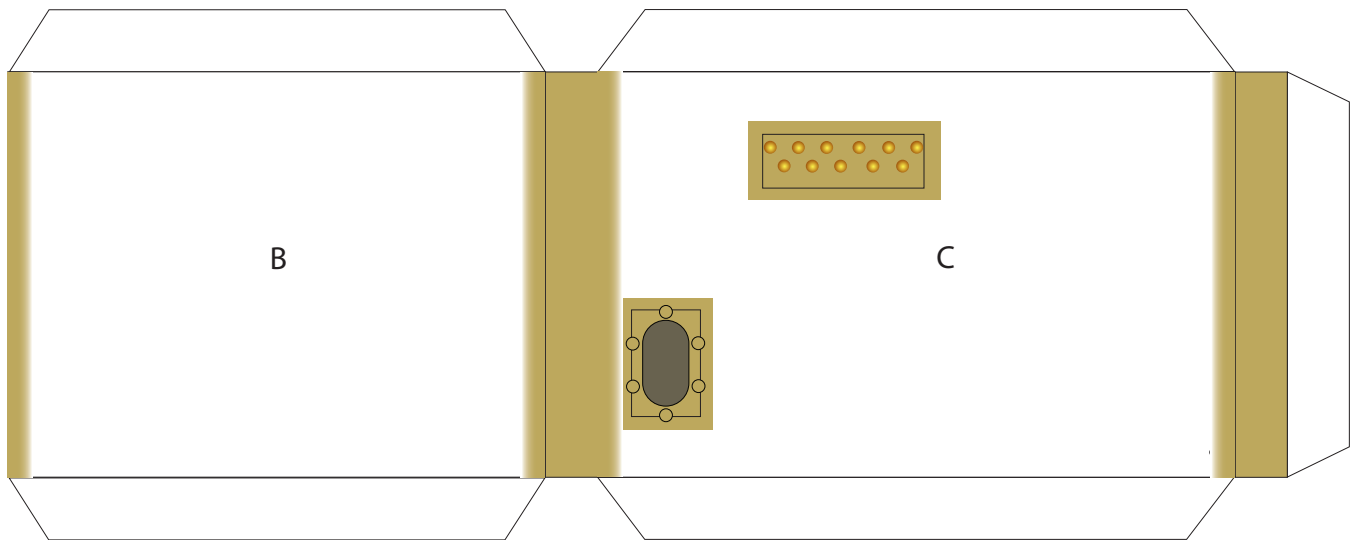

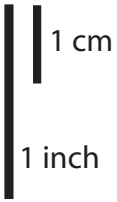

Print on Cardstock (110 lbs)

Sheet 5

SCaN Testbed

Top of box

1:10 Scale

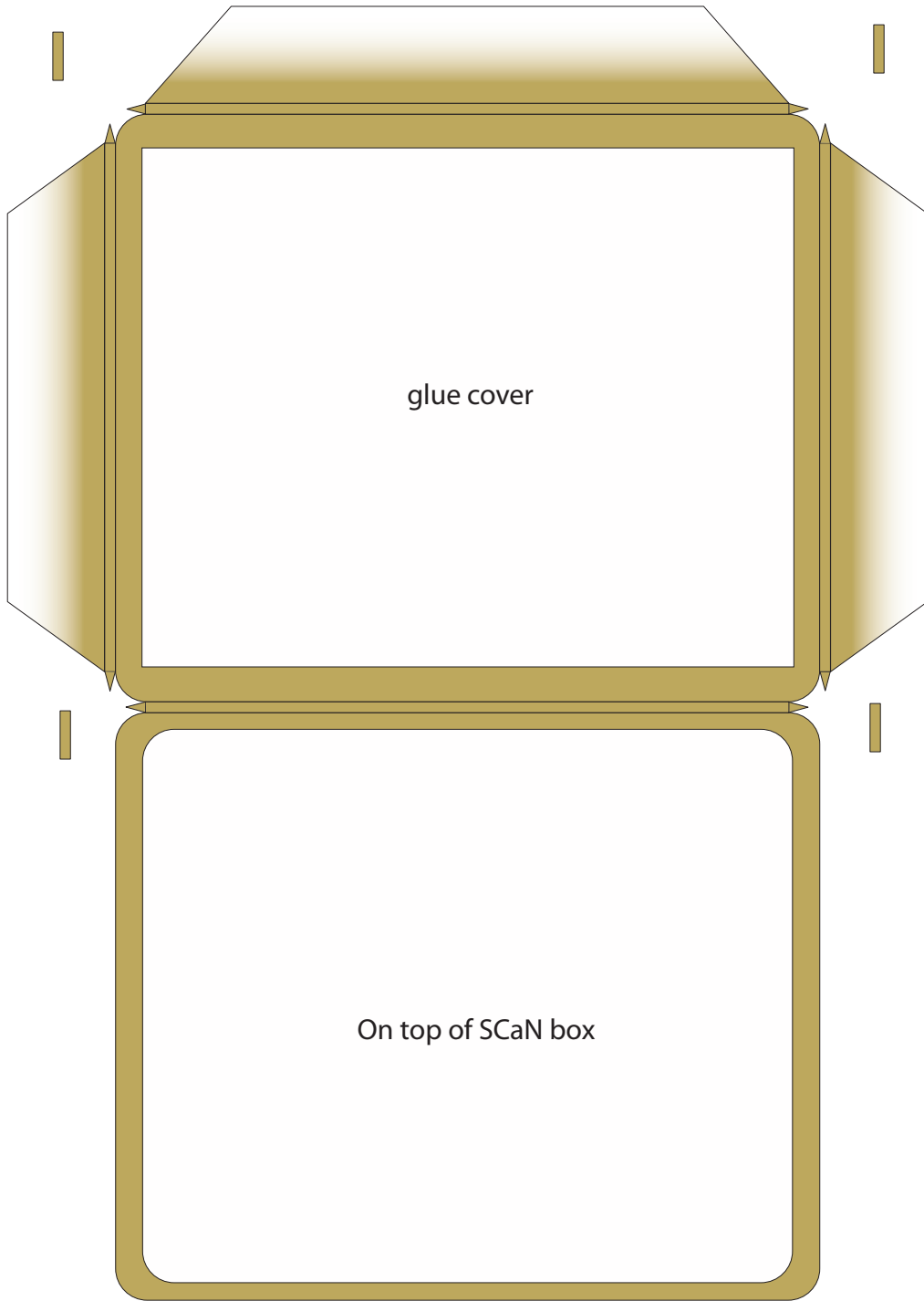

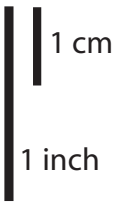

Print on Cardstock (110 lbs)

Sheet 6

SCaN Testbed

1:10 Scale

Antenna Arm

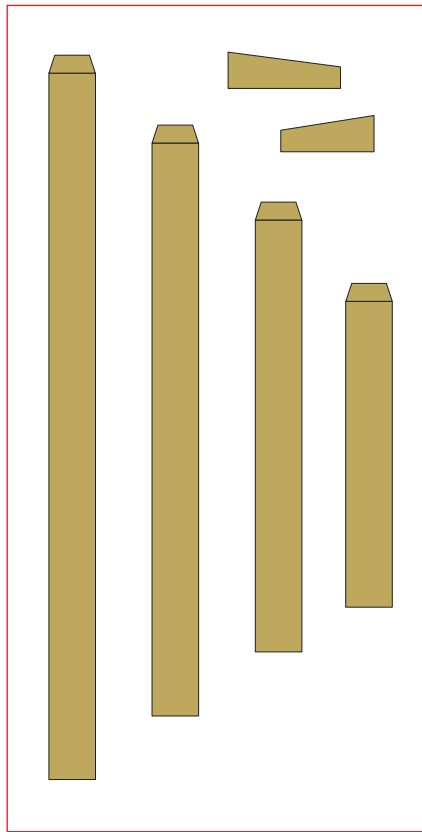
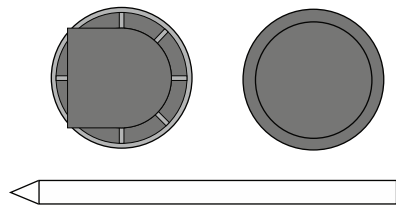
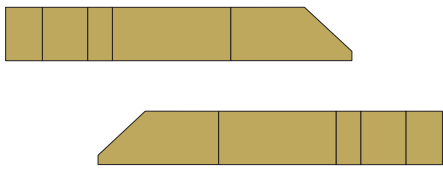
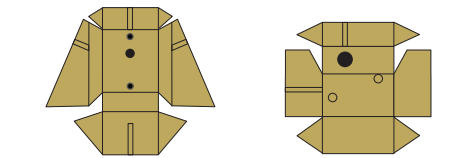
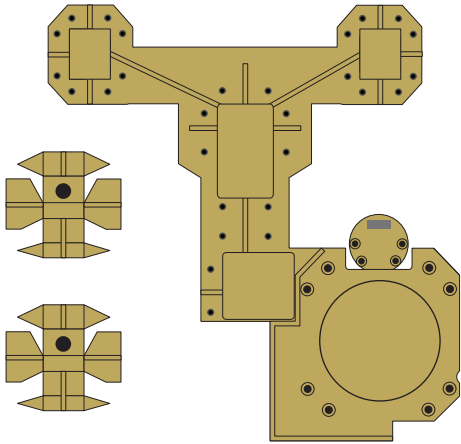
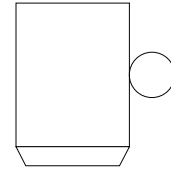
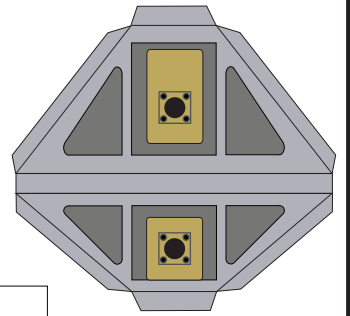
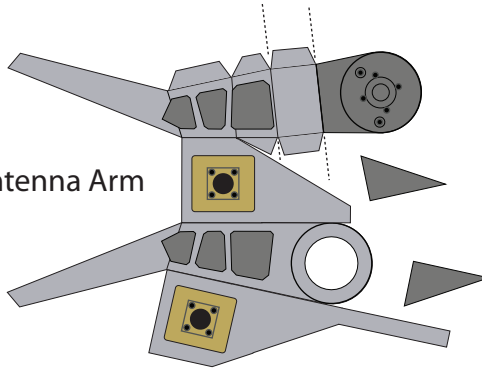

L-band
GPS Antenna

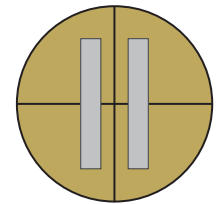
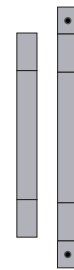
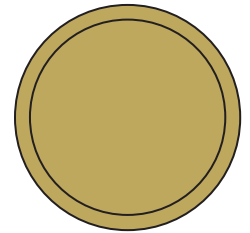
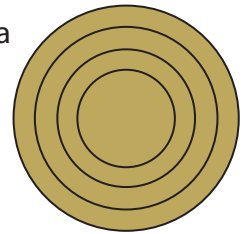
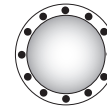

S-band LGA
Antenna

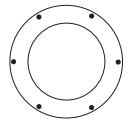
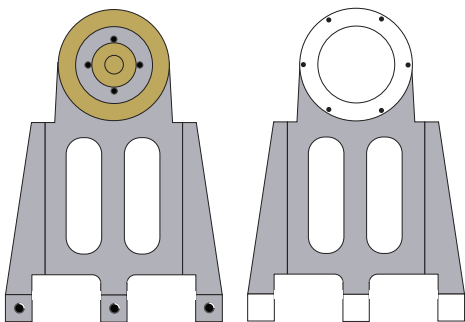

S-band LGA
Antenna

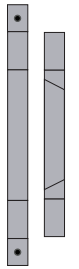
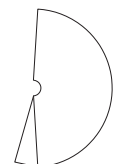
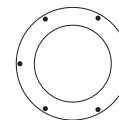
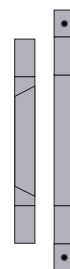

SCaN Testbed

Back print page

(Used for GPS antenna circles)

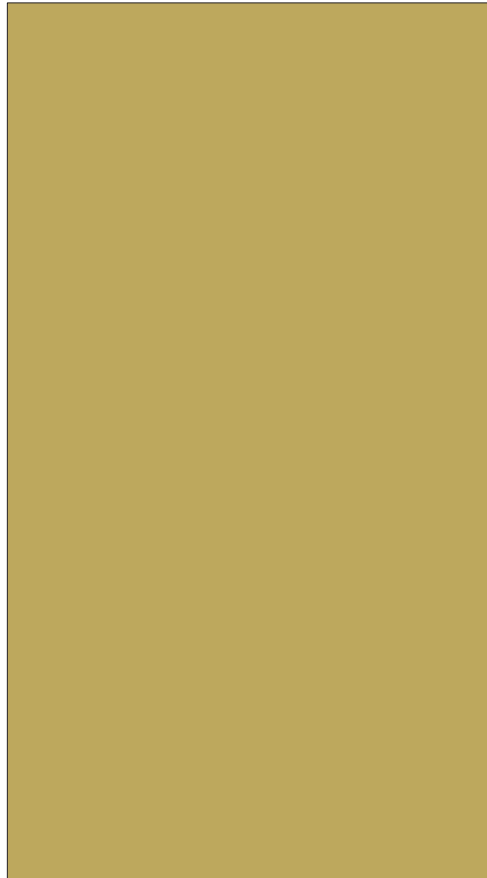

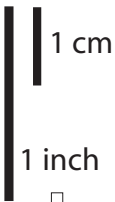

Print on Cardstock (110 lbs)

Sheet 8

SCaN Testbed

1:10 Scale

Ka-Band HGA antenna

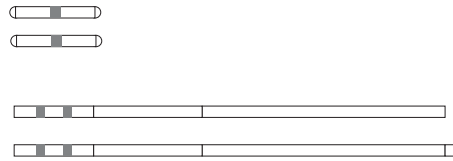
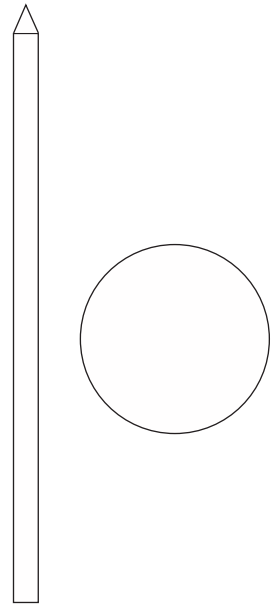
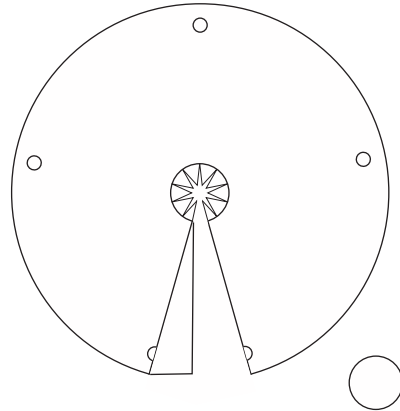
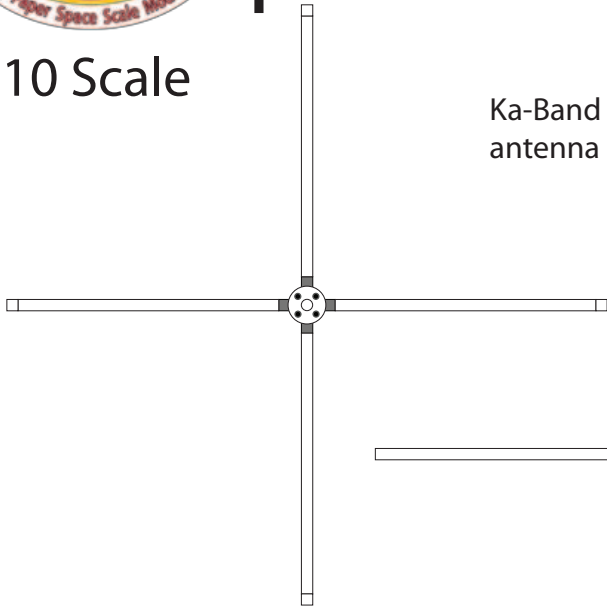

Antenna Plate

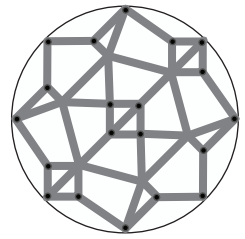
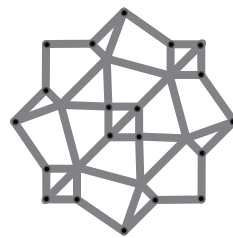
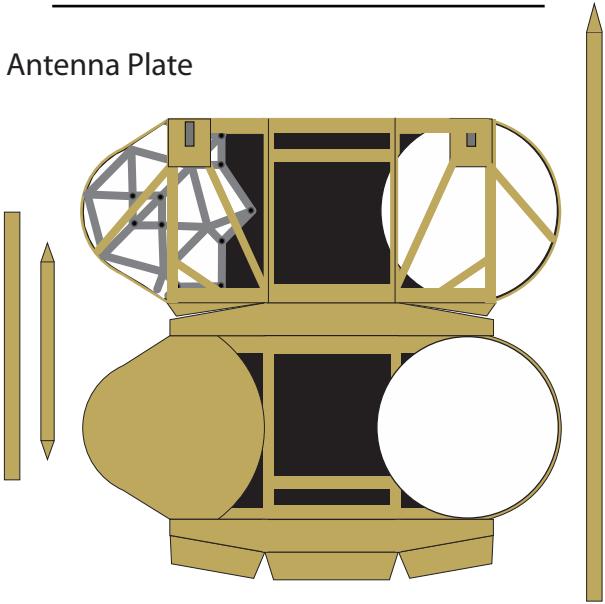

S-Band MGA antenna

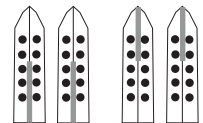
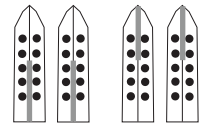
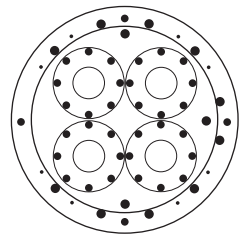
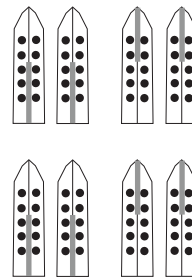

Integrated Gimbal Assembly

